

C  US
E167996

R50056114

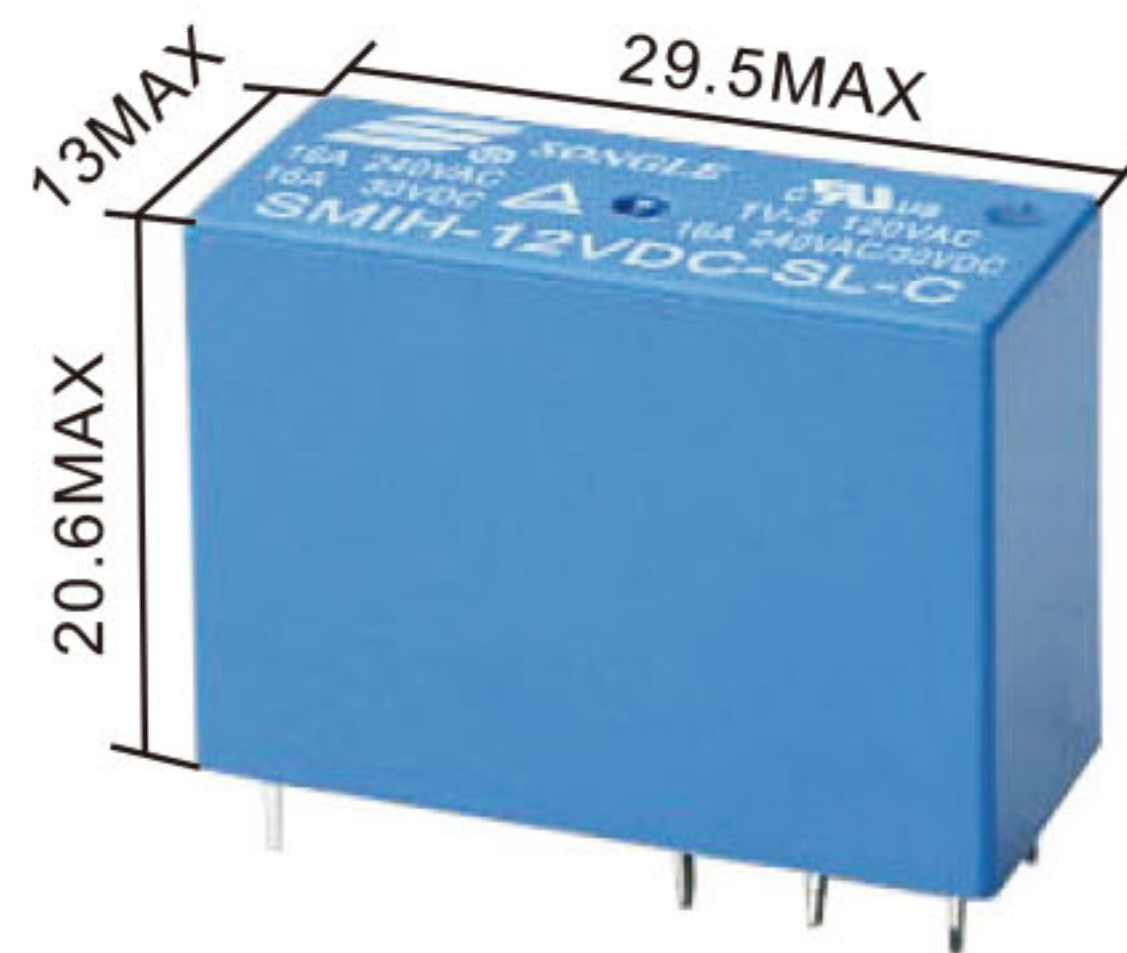

Features

- Miniature volume, PCB usage
- Contact rating: 16A
- Temperature range: -40°C/+85°C
- Creepage distance 6mm can reach the enhanced insulation standard

Ordering Information

SMIH-12VDC-S L-C

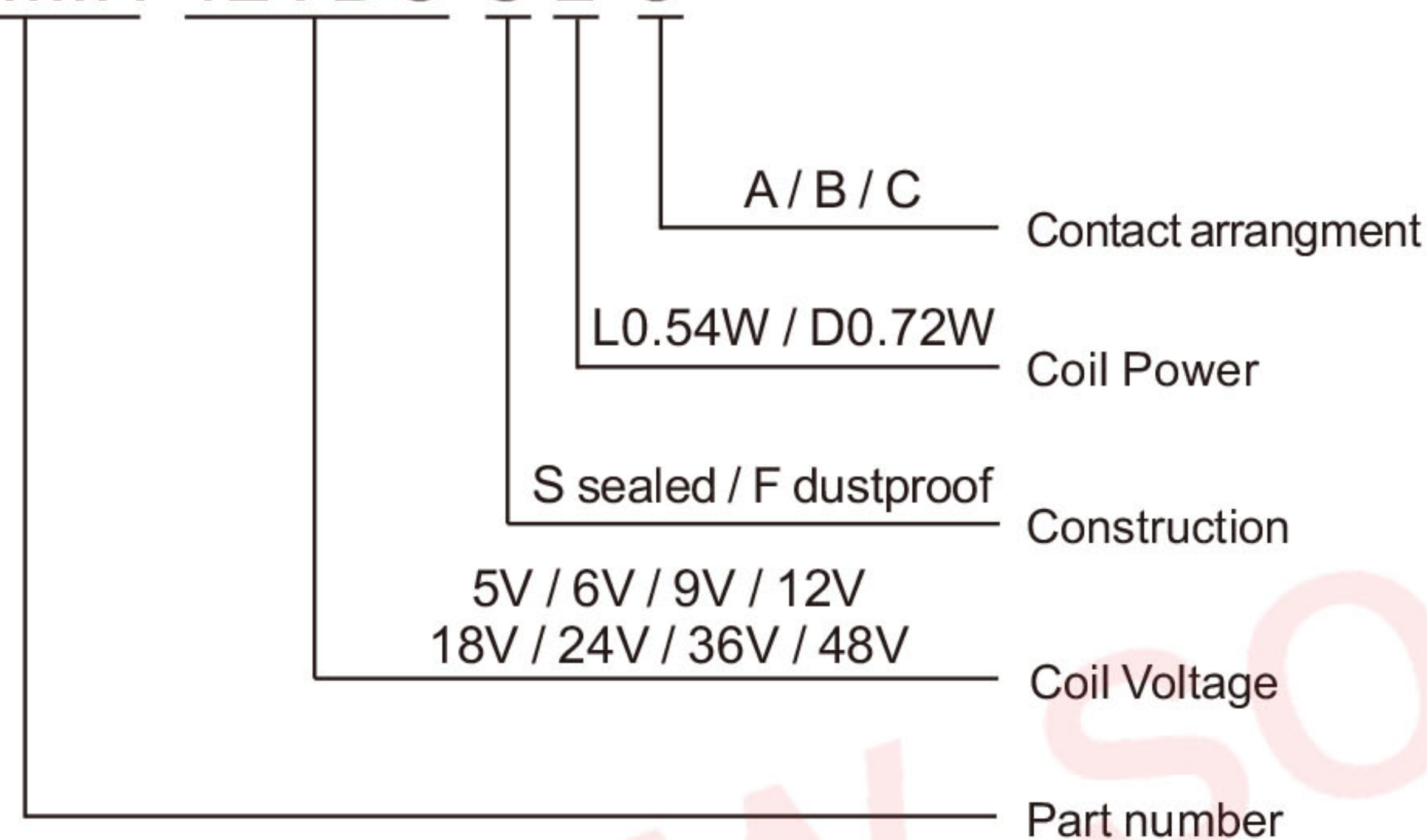

Contact Rating

Contact arrangement	A / B / C
Contact resistance	100mΩ
Contact material	Silver alloy: AgCdO、AgSnO ₂ 、AgNi
Contact rating	TV-5/120VAC 3A/6A250VAC 16A/250VAC
Max switching voltage	250VAC
Max switching current	16A
Max switching power	4000VA
Electrical endurance (frequency: 1800 ops/h)	1x10 ⁵ ops / 1x10 ⁴ ops
Mechanical endurance (frequency: 18000 ops/h)	1x10 ⁷ ops

Characteristics

Insulation system	B / F	
Insulation resistance	100MΩ (500VDC)	
Dielectric Strength Leakage current 1mA	Between contacts and coil	5000VAC 1 minute
	Between open contacts	1000VAC 1 minute
Operate time(Under nominal voltage)	≤10ms	
Release time(Under nominal voltage)	≤10ms	
Humidity	45% ~85% RH (20°C)	
Ambient Temperature	-40°C~+85°C	
Shock resistance	Functional	98m/s ²
	Destructive	980m/s ²
Vibration resistance (Double amplitude)	10Hz~55Hz 1.5mm	
Weight	Approx15g	
Construction	Sealed	

Remark:1)All above data is initial value

Coil Data

(at 20°C)

Power dissipation W	Voltage VDC	Current mA	Resistance Ω ± 10%	Pick-up voltage	Drop-out voltage	Max allowable
0.72W (D)	05	144	34.7	75%Max	5%Min	130%
	06	120	50			
	09	80	112.5			
	12	60	200			
	18	40	450			
	24	30	800			
	36	20	1800			
0.54W (L)	05	108	46.3	75%Max	5%Min	130%
	06	90	66.7			
	09	60	150			
	12	45	267			
	18	30	600			
	24	22.5	1067			
	36	15	2400			
48	11.2	4267				

This product specification only for your reference, we will not notify you if we do any improvement. We reserve all the right for the final explanation



Web: www.songle.com www.songlerelay.com

Add.: CW7, Zone A, Far East Industrial Park, Yuyao City, Zhejiang, China Zip Code: 315400

Safety Approval Ratings

 R50056114
3A 250VAC inductive 16A 250VAC

 US E167996
TV-5 120VAC inductive 16A 250VAC

OUTLINE DIMENSIONS ,WIRING DIAGRAM AND PC BOARD LAYOUT Unit:mm

Physical installation diagram

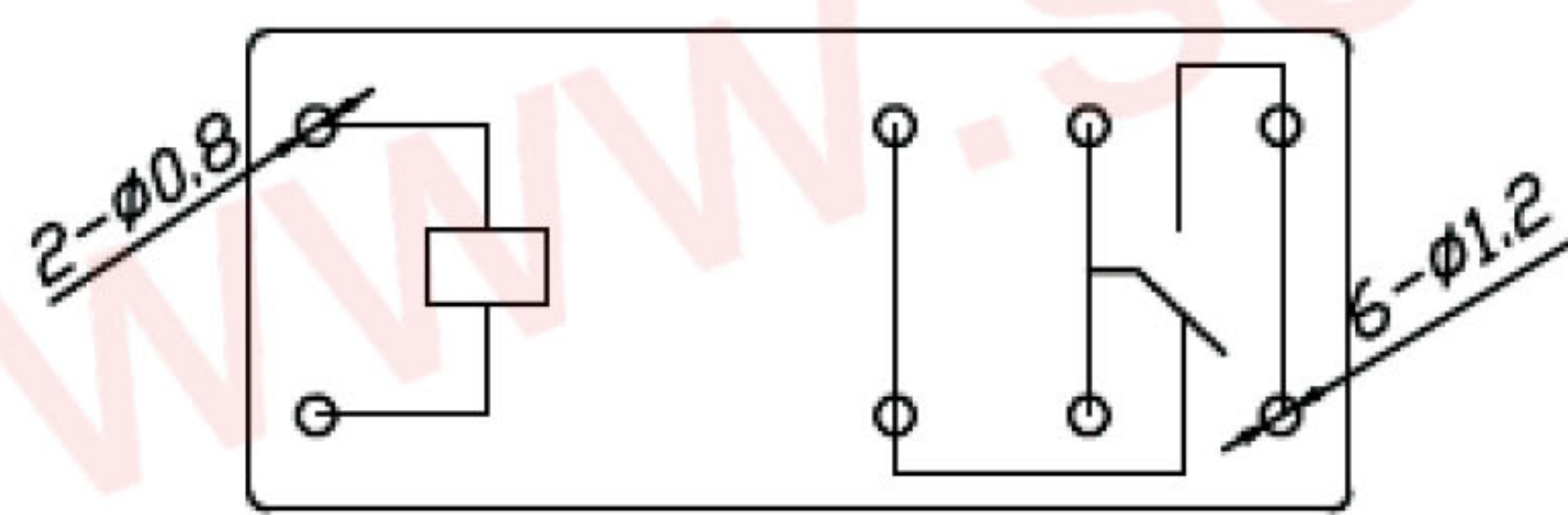
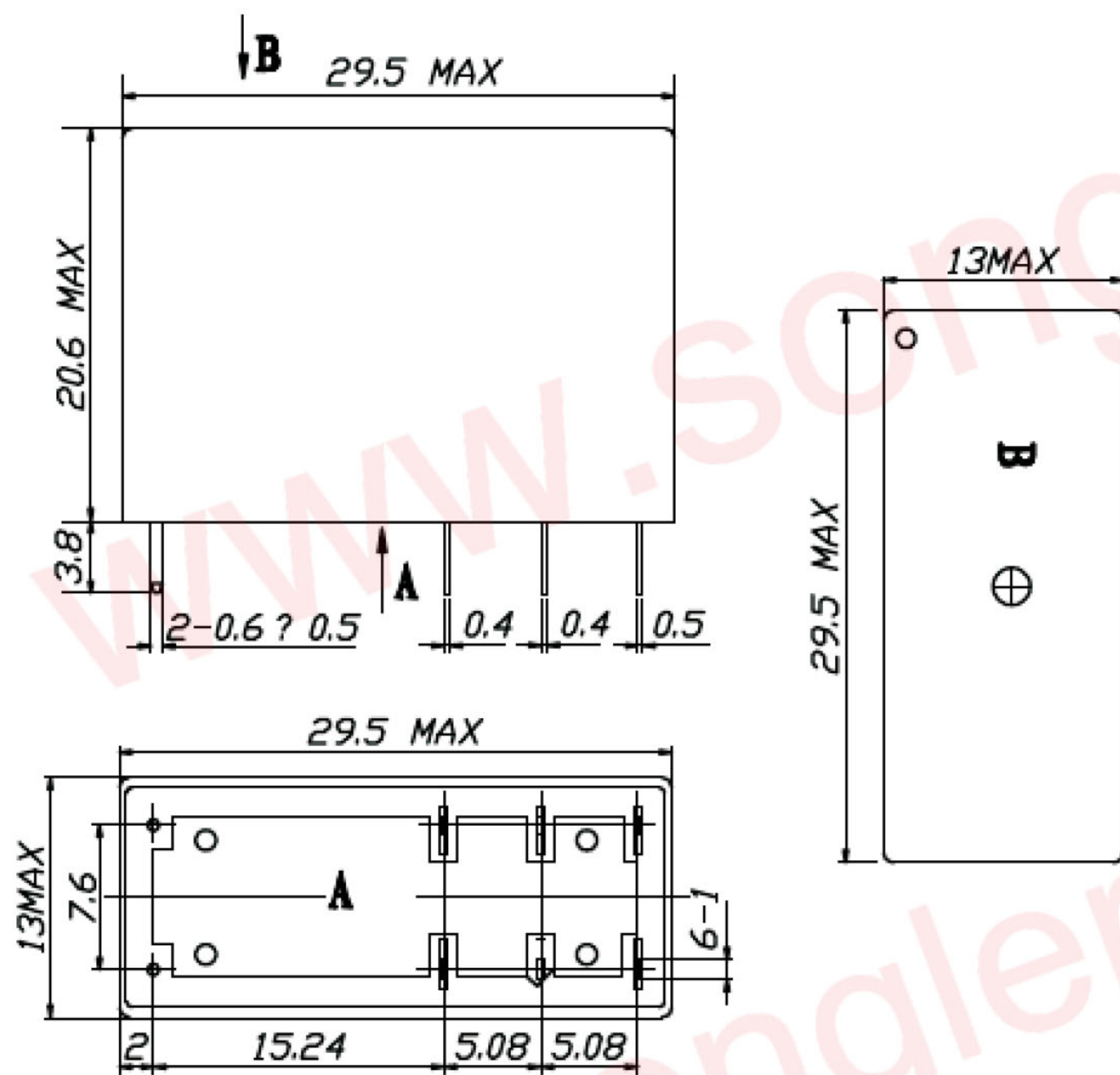

Electrical Diagram

Tolerance: ±0.1mm

PCB board diagram (bottom view diagram)

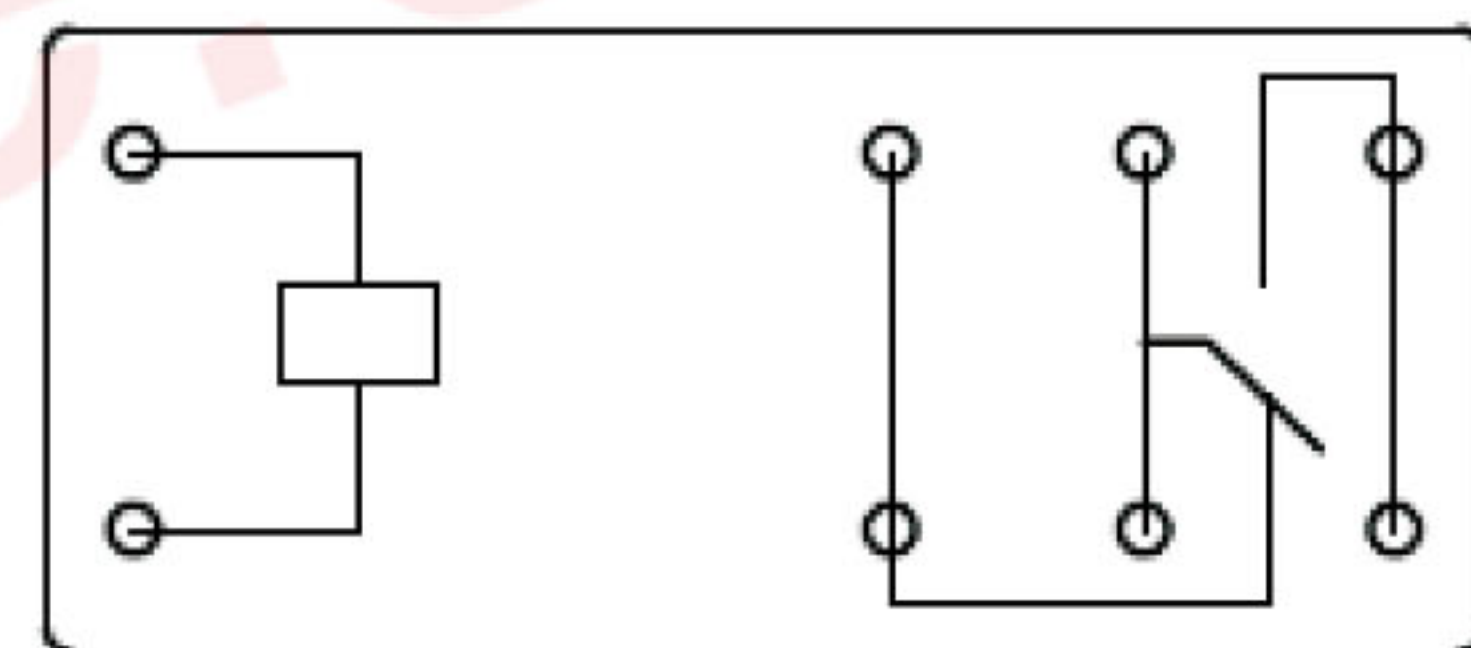

Conversion C type

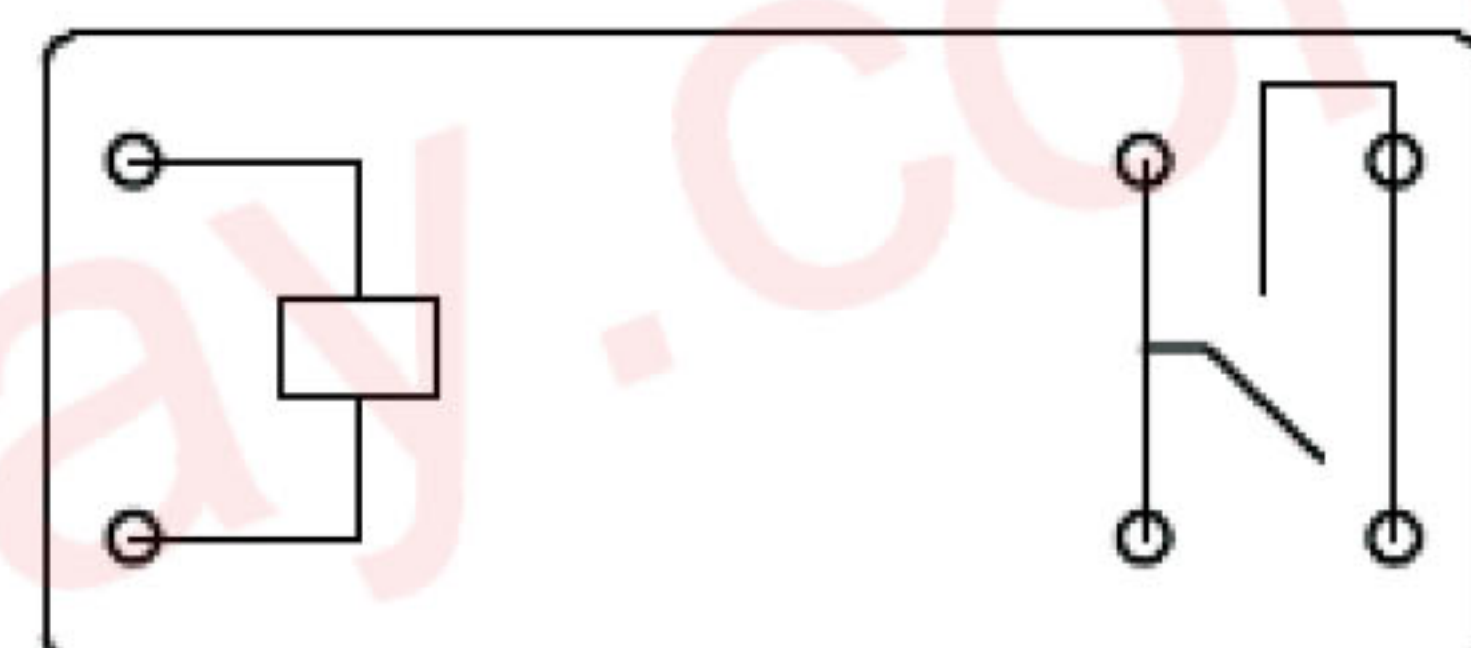

Normally open A type

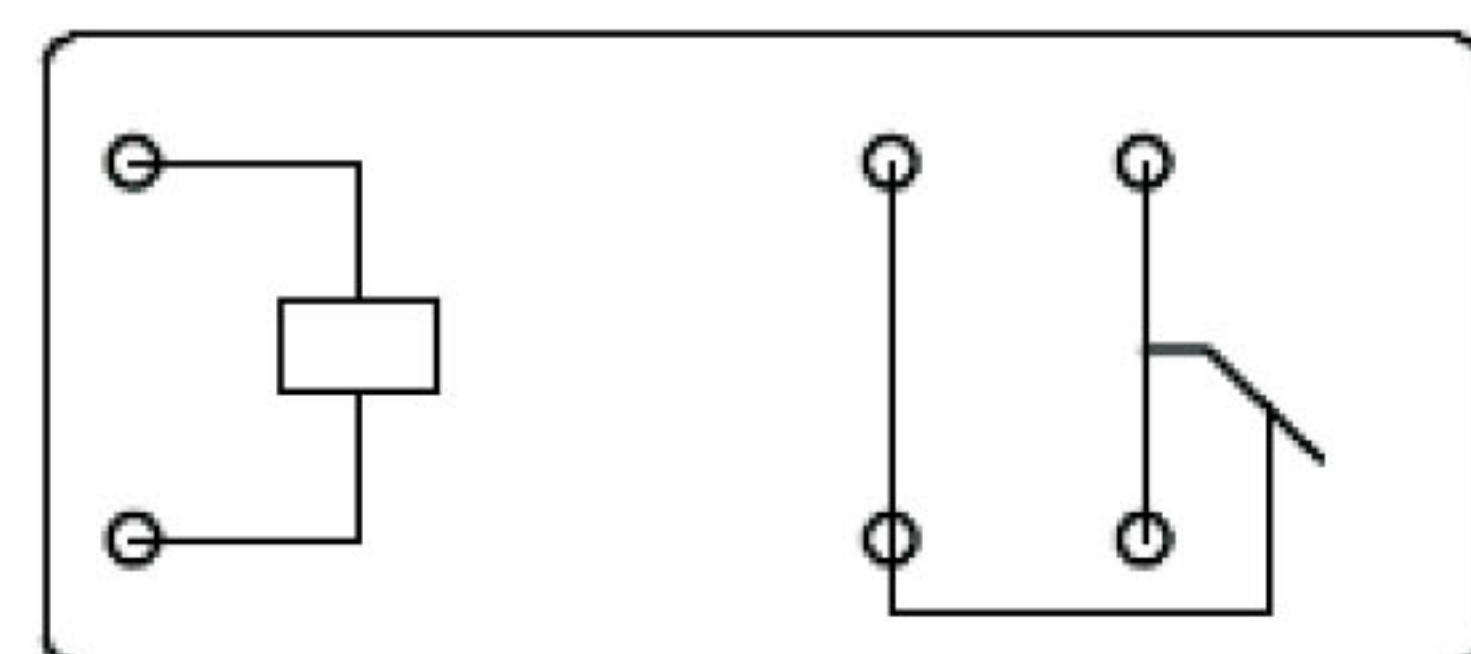

Normally closed B type

This product specification only for your reference, we will not notify you if we do any improvement. We reserve all the right for the final explanation