

DHT20 Product Manual

Temperature and humidity sensor

- Fully calibrated
- Digital output, I²C interface
- Excellent long-term stability
- Quick response and anti-interference capability
- Wide voltage support 2.5-5.5V DC



Product Overview

DHT20 is equipped with a newly designed ASIC dedicated chip, an improved MEMS semiconductor capacitive humidity sensor element and a standard on-chip temperature sensor element. Its performance has been greatly improved or even exceeded the reliability level of the previous generation of sensors. The temperature and humidity sensor has been improved to make its performance in harsh environments more stable. Every sensor has been rigorously calibrated and tested. Due to the improvement and miniaturization of the sensor, it is more cost-effective.

Applied range

HVAC, Dehumidifier, Testing and Inspection Equipment, Consumer Goods, Automobile, Automatic Control, Data Recorder, Weather Station, Home Appliance, Humidity Control, Medical Treatment and other related temperature and humidity detection control project.

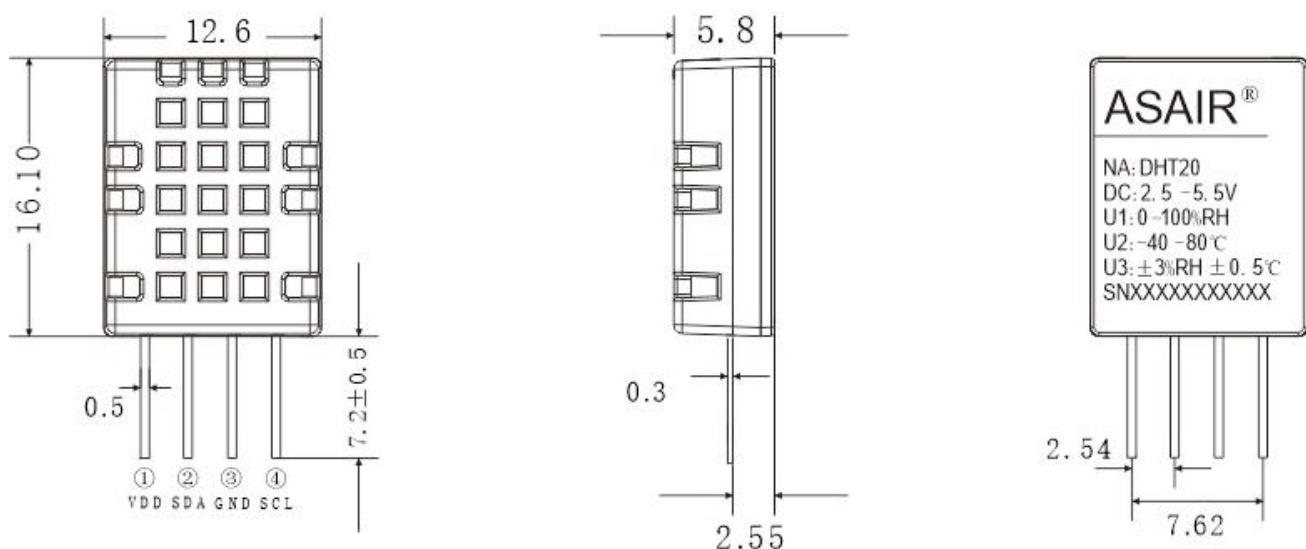

Figure 1 DHT20 sensor package diagram (unit: mm unmarked tolerance: ± 0.2 mm)

Sensor capability

Relative humidity

parameter	condition	min	typical	max	unit
resolution	typical		0.024		%RH
Accuracy Error ¹	typical		±3		%RH
	max	See Figure 2			%RH
repeatable			±0.1		%RH
hysteresis			±1		%RH
nonlinear			<0.1		%RH
Response time ²	t 63%		8		S
Scope of work	Extended ³	0		100	%RH
Prolonged Drift ⁴	normal		<0.5		%RH/yr

Table 1 Humidity characteristics table

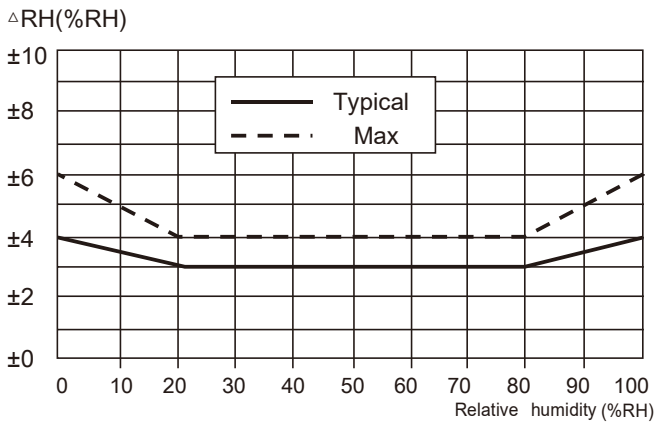

Figure 2 Typical and maximum error in relative humidity at 25°C

Temperature

parameter	condition	min	typical	max	unit
resolution	typical		0.01		°C
Accuracy error ¹	typical		±0.5		°C
	max	See Figure 3			°C
repeatable			±0.1		°C
hysteresis			±0.1		°C
nonlinear					°C
Response time	t 63%	5		30	S
Scope of work	Extended ³	-40		80	°C
Prolonged Drift			<0.04		°C/yr

Table 3 Temperature Characteristic table

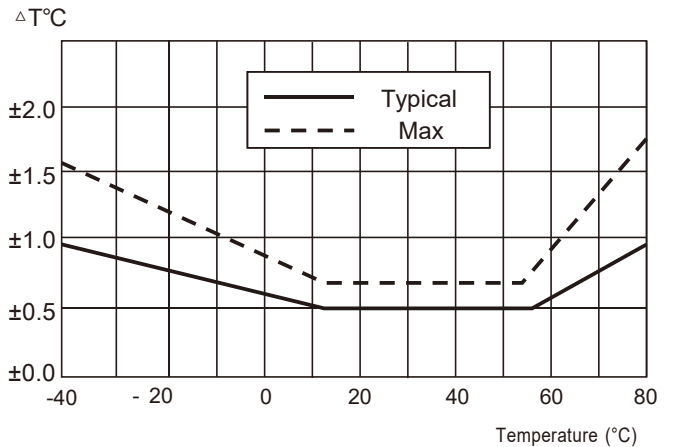

Figure 3 Typical and maximum temperature errors

Electrical specification

parameter	condition	min	typical	max	unit
Supply voltage	typical	2.5	3.3	5.5	V
Supply current, I _{DD} ⁵	dormancy	-	250		nA
	measure		980		μA
Power consumption ⁶	dormancy	-		0.8	μW
	measure		3.2		mW
communication	Two-wire digital interface, standard I ² C protocol				

Table 2 Electrical characteristics

1. This accuracy is based on the sensor's test accuracy at a supply voltage of 3.3V at 25°C when tested at the factory. This value does not include hysteresis and non-linearity and applies only to non-condensing conditions.

2. Time required to achieve 63% first-order response at 25°C and 1 m/s airflow.

3. Normal operating range: 0-80%RH, beyond this range, there will be deviation in the sensor reading (after 200 hours in 90%RH humidity, drift <3%RH).

Packaging information

Sensor model	Packaging	Number
DHT20	Pallet packaging	50pcs/plate(Each 2 plates are put into an anti-static bag, a total of 100pcs)

Table 4 Packaging information.

4. Readings may be high if the sensor is surrounded by volatile solvents, offensive odor tapes, adhesives, and packaging materials. Please refer to the relevant documentation for detailed instructions.

5. The minimum and maximum values for supply current and power consumption are based on VCC = 3.3V and T < 60°C. The mean value is the value of one measurement taken in every two seconds.

6. The response time depends on the thermal conductivity of the sensor substrate.

DHT20 User Guide

1 Expansion performance

1.1 Operating conditions

The sensor has stable performance within the recommended working range, as shown in Figure 4. Long-term exposure to conditions outside the normal range, especially when the humidity is > 80%, may cause temporary signal drift (drift + 3% RH after 60 hours). After returning to normal working conditions, the sensor will slowly self-recover to the calibration state. Refer to "Recovery Processing" in section 2.3 to speed up the recovery process. Long-term use under abnormal conditions will accelerate the aging of the product.

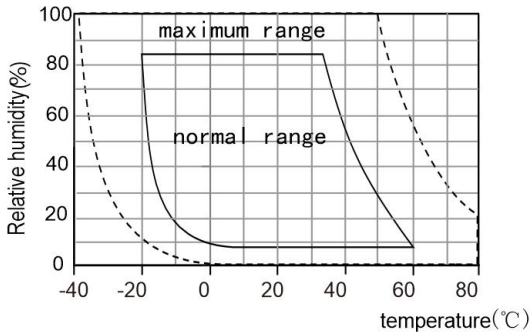

Figure 4 Working conditions

1.2 RH accuracy at different temperatures

Figure 2 defines the RH accuracy at 25°C, and Figure 5 shows the typical humidity error for other temperature ranges.

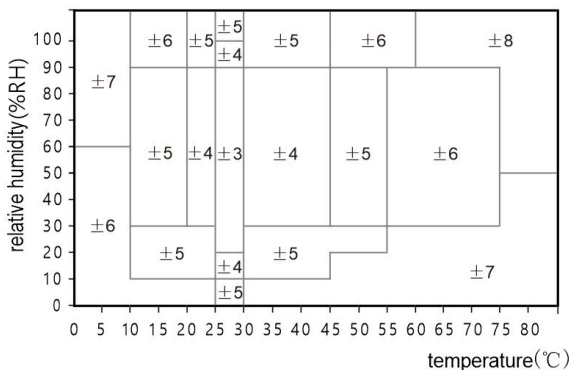

Figure 5 The typical error of humidity in the range of 0~80°C, unit: (%RH)

Please note: The above error is the typical error (excluding hysteresis) of the reference instrument test with a high-precision dew point meter.

1.3 Electrical characteristics

The power consumption given in Table 2 is related to temperature and supply voltage VDD. Refer to Figures 6 and 7 for power consumption estimation. Please note that the curves in Figures 6 and 7 are typical natural characteristics, and there may be deviations.

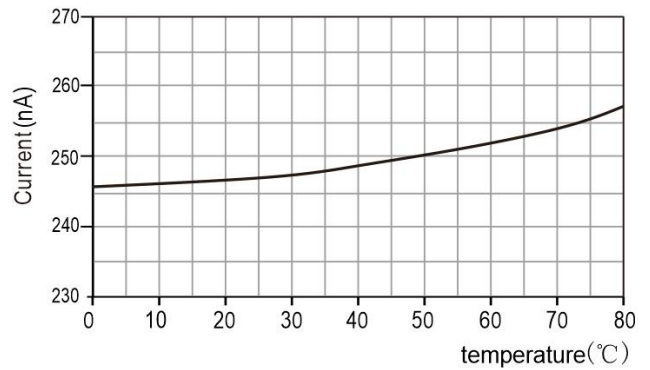

Figure 6 Typical supply current vs. temperature curve (sleep mode) when VDD=3.3V.

Please note that there is a deviation of approximately ±25% between these data and the displayed value.

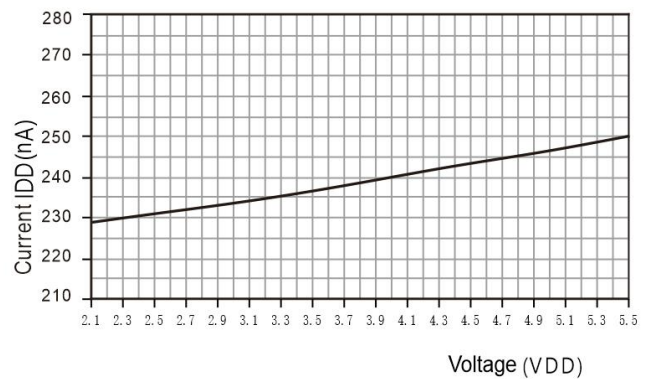

Figure 7 The relationship between typical supply current and supply voltage at 25°C

Curve(sleep mode), please note that the deviation of these data from the displayed value may reach ±50% of the displayed value. At 60°C, the coefficient is about 15 (Compared with table 2).

2 Applications

2.1 Welding Instructions

It is forbidden to use reflow soldering or wave soldering for soldering. The manual soldering must be contacted for less than 5 seconds under the temperature condition of the highest 350°C.

Note: After welding, the sensor needs to be stored in an environment of >75%RH for at least 12 hours to ensure the rehydration of the polymer. Otherwise, the sensor readings will drift. The sensor can also be placed in a natural environment (>40%RH) for more than 5 days to rehydrate it. The use of low temperature solder (for example: 180°C) can reduce the hydration time.

If the sensor is used in corrosive gas or condensed water (such as: high humidity environment), the pin pad and PCB need to be sealed (such as: use conformal coating) to avoid poor contact or short circuit.

2.2 Storage conditions and operating instructions

The humidity sensitivity level (MSL) is 1, according to the IPC/JEDEC J-STD-020 standard. Therefore, it is recommended to use it within one year after shipment.

The temperature and humidity sensor is not an ordinary electronic component and needs to be carefully protected. Users must pay attention to this point. Long-term exposure to high concentrations of chemical vapor will cause the sensor's readings to drift. Therefore, it is recommended to store the sensor in the original packaging including a sealed ESD bag, and meet the following conditions: temperature range 10°C-50°C (within a limited time 0-85°C); humidity 20-60%RH (without ESD package sensor). For those sensors that have been removed from the original packaging, we recommend storing them in an antistatic bag made of PET/AL/CPE containing metal.

During production and transportation, the sensor should avoid contact with high concentrations of chemical solvents and long-term exposure. Avoid contact with volatile glues, tapes, stickers or volatile packaging materials, such as foam foils and foam materials. Wait. The production area should be well ventilated.

2.3 Recovery processing

As mentioned above, if the sensor is exposed to extreme working conditions or chemical vapors, the readings will drift. It can be restored to the calibration state by the following processing.

Drying: Keep for 10 hours under 80-85°C and <5%RH humidity conditions;

Rehydration: Keep for 12 hours under 20-30°C and >75%RH humidity conditions⁷.

2.4 Temperature effect

The relative humidity of the gas depends to a large extent on the temperature. Therefore, when measuring humidity, it is necessary to ensure that all sensors measuring the same humidity work at the same temperature. When doing the test, make sure that the tested sensor and the reference sensor are at the same temperature, and then compare the humidity readings.

In addition, when the measurement frequency is too high, the sensor's own temperature will rise, which will affect the measurement accuracy. If you want to ensure that its own temperature rise is less than 0.1°C, the activation time of DHT20 should not exceed 10% of the measurement time. It is recommended to measure the data every 2 seconds.

⁷75%RH can be easily generated from saturated NaCl.

2.5 Materials for sealing and encapsulation

Many materials absorb moisture and will act as a buffer, which will increase response time and lag. Therefore, the materials around the sensor should be carefully selected. The recommended materials are: metal materials, LCP, POM(Delrin), PTFE(Teflon), PE, PEEK, PP, PB, PPS, PSU, PVDF, PVF.

Material used for sealing and bonding (conservative recommendation): It is recommended to use epoxy resin to encapsulate electronic components, or silicone resin. The gases released by these materials may also contaminate DHT20(see 2.2). Therefore, the sensor should be assembled last, and placed in a well-ventilated place, or dried for 24 hours in an environment of >50°C, so as to release the polluted gas before packaging.

2.6 Wiring rules and signal integrity

If the SCL and SDA signal lines are parallel and very close to each other, it may cause signal crosstalk and communication failure. The solution is to place VDD and/or GND between the two signal lines, separate the signal lines, and use shielded cables. In addition, reduce

SCL frequency may also improve the integrity of signal transmission. A 100nF decoupling capacitor must be added between the power supply pins (VDD, GND) for filtering. This capacitor should be as close as possible to the sensor. See the next chapter.

3 Interface definition

Pins	Name	Description
1	VDD	Power supply(2.5V to 5.5V)
2	SDA	Serial Data, Bidirectional Port
3	GND	Ground
4	SCL	Serial Clock, Bidirectional Port

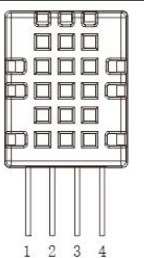

Table 5 DHT20 pin distribution (top view)

3.1 Power pin(VDD,GND)

The power supply range of DHT20 is 2.5-5.5V, and the recommended voltage is 3.3V. A 100nF decoupling capacitor must be connected between the power supply (VDD) and ground (GND), and the position of the capacitor should be as close as possible to the sensor-refer to Figure 8.

3.2 Serial clock SCL

The serial clock is used to synchronize the communication between the microprocessor and DHT20. Since the interface contains completely static logic, there is no minimum SCL frequency.

3.3 Serial data SDA

The SDA pin is used for data input and output of the sensor. When sending a command to the sensor, SDA is valid on the rising edge of the serial clock (SCL), and when SCL is high, SDA must remain stable. After the falling edge of SCL, the SDA value can be changed. To ensure communication safety, the effective time of SDA should be extended by TSU and THO before the rising edge and after the falling edge of SCL refer to Figure 9. When reading data from the sensor, SDA is valid (TV) after SCL goes low, and is maintained until the next falling edge of SCL.

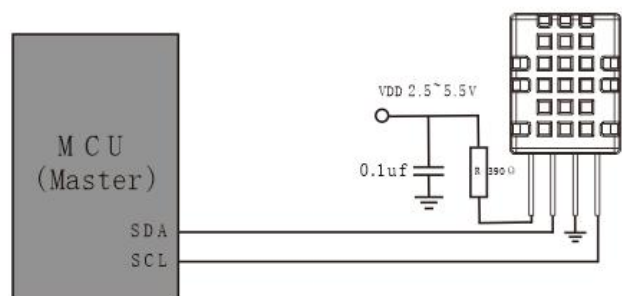

Figure 8 Typical application circuit, including the RC circuit between VDD and GND

Note:

1. The power supply voltage of the host MCU must be consistent with the sensor when the product is in use in the circuit;
2. If you need to further improve the reliability of the system, you can control the sensor power supply;
3. Only a single DHT20 can be connected to the I2C bus, and other I2C devices cannot be connected;
4. The supply voltage range of the host MCU to DHT20 is 2.5~5.5V;
5. When the sensor is just powered on, the MCU will give priority to VDD, and SCL and SDA can be set to high levels

To avoid signal conflicts, the microprocessor (MCU) must only drive SDA and SCL at low level. An external pull-up resistor (for example: 4.7kΩ) is required to pull the signal to a high level. The pull-up resistor has been included in the I/O circuit of the DHT20 microprocessor. Refer to Table 7 and Table 8 for detailed information about sensor input/output characteristics.

4 Electrical characteristics

4.1 Absolute maximum ratings

The electrical characteristics of DHT20 are defined in Table 1. The absolute maximum ratings given in Table 6 are only stress ratings and provide more information. Under such conditions, it is not advisable for the device to perform functional operations. Exposure to absolute maximum ratings for a long time may affect the reliability of the sensor.

parameters	Min	Max	Unit
VDD to GND	-0.3	5.5	V
Digital I/O Pins (SDA,SCL) to GND	-0.3	VCC+0.3	V
Input current per pin	-10	10	mA

Table 6 Absolute maximum electrical ratings

ESD electrostatic discharge conforms to JEDECJESD22-A114 standard (human body model ±4kV), JEDECJESD22-A115 (machine model ±200V). If the test condition exceeds the nominal limit index, the sensor needs to add an additional protection circuit.

4.2 Input/output characteristics

Electrical characteristics, such as power consumption, input and output high and low voltages, etc., depend on the power supply voltage. In order to make the sensor communication smooth, it is very important to ensure that the signal design is strictly limited to the range given in Table 7, 8 and Figure 9).

parameters	conditions	Min	typical	Max	unit
Low output voltage VOL	VDD=3.3V, -4mA<IOL<0mA	0	-	0.4	V
High output voltage VOH		70% VDD	-	VDD	V
Output sink current IOL		-	-	-4	mA
Low output voltage VIL		0	-	30% VDD	V
High output voltage VIH		70% VDD	-	VDD	V
Input Current	VDD=5.5V,VI N=0Vto5.5V	-	-	±1	uA

Table 7 DC characteristics of digital input and output pads, if there is no special statement VDD=2.5Vto5.5V T=-40°Cto80°C

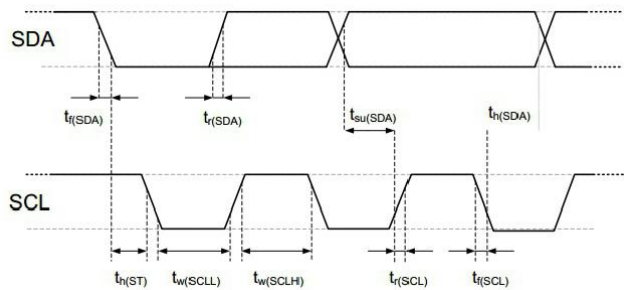

Figure 9 Timing diagram of digital input/output

The abbreviations are explained in Table 8. The thicker SDA line is controlled by the sensor, and the ordinary SDA line is controlled by the single-chip microcomputer. Please note that the SDA valid read time is triggered by the falling edge of the previous conversion.

parameters	mark	I ² C typical model		I ² C High-speed mode		unit
		MIN	MAX	MIN	MAX	
I ² C clock frequency	fSCL	0	100	0	400	KHz
Start signal time	tHDSTA					μs
SCL Clock High Width	tHIGH	4.7		1.3		μs
SCL Clock low Width	tLOW	4.0		0.6		μs
Data setup time vs. SCL SDA edge	tHDDAT	0.09	3.45	0.02	0.9	μs
Data save time vs. SCL SDA edge	tSUDAT	250		100		μs

Note: Measurements for both pins are from 0.2 VDD and 0.8 VDD.
 Note: The above I²C timing is determined at the following internal delays.
 (1) Internal SDI input pin is delayed relative to the SCK pin, typically 100 ns.
 (2) Internal SDI output pin delay with respect to SCK falling edge, typically 200ns.

Table 8 Timing characteristics of I²C fast mode digital Inputs/outputs
The meaning is shown in Figure 12. Unless otherwise noted.

5 Sensor communication

DHT20 uses standard I2C protocol for communication. For information about the I2C protocol other than the following chapters, please refer to the following website: www.aosong.com provides a sample program for reference.

5.1 Start the sensor

The first step is to power up the sensor with the selected VDD supply voltage (range between 2.5V and 5.5V). After power-on, the sensor needs 100ms~500ms time (SCL is high at this time) to reach the idle state and it is ready to receive commands sent by the host (MCU).

5.2 Start/stop sequence

Each transmission sequence starts with the Start state and ends with the Stop state, as shown in Figure 10 and Figure 11.

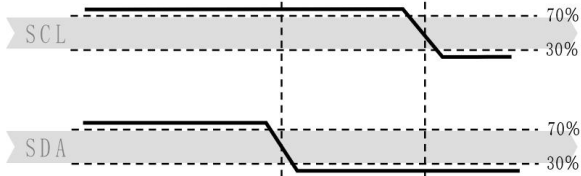

Figure 10 Start transmission status (S)

When SCL is high, SDA is converted from high to low. The start state is a special bus state controlled by the master, indicating the start of the slave transfer (after Start, the BUS bus is generally considered to be in a busy state)

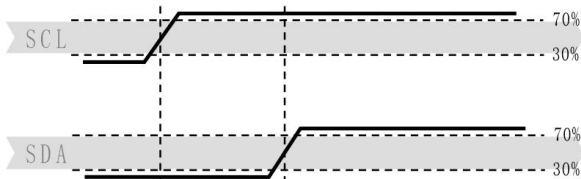

Figure 11 Stop transmission state (P)

When SCL is high, the SDA line changes from low to high. The stop state is a special bus state controlled by the master, indicating the end of the slave transmission (after Stop, the BUS bus is generally considered to be in an idle state).

5.3 Send Command

After the transmission is started, the first byte of IC2 that is subsequently transmitted includes the 7-bit IC2 device address 0x38 and a SDA direction bit x (read R: '1', write W: '0'). After the 8th falling edge of the SCL clock, pull down the SDA pin (ACK bit) to indicate that the

sensor data is received normally. After sending the measurement command 0xAC, the MCU must wait until the measurement is completed.

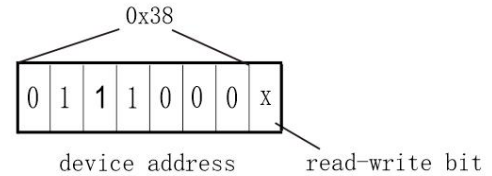

Bits	Significance	Description
Bit[7]	Busy indication	1-Equipment is busy, in measurement mode 0- Equipment is idle, in hibernation state
Bit[6:5]	Retain	Retain
Bit[4]	Retain	Retain
Bit[3]	CAL Enable	1 - Calibrated 0 - Uncalibrated
Bit[2:0]	Retain	Retain

Table 9 Status bit description

5.4 Sensor reading process

1.After power-on, wait for 100ms~500ms. Before reading the temperature and humidity value, get a byte of status word by sending 0x71. If the status word and 0x18 are not equal to 0x18, initialize the 0x1B, 0x1C, 0x1E registers, details Please refer to our official website routine for the initialization process; if they are equal, proceed to the next step

2.Wait 10ms to send the 0xAC command (trigger measurement). This command parameter has two bytes, the first byte is 0x33, and the second byte is 0x00.

3.Wait 80ms for the measurement to be completed, if the read status word Bit[7] is 0, it means the measurement is completed, and then six bytes can be read continuously; otherwise, continue to wait.

4.After receiving six bytes, the next byte is the CRC check data. The user can read it out as needed. If the receiving end needs CRC check, an ACK will be sent after the sixth byte is received. Reply, otherwise send NACK to end, the initial value of CRC is 0xFF, and the CRC8 check polynomial is:

$$CRC[7:0] = 1 + X^4 + X^5 + X^8$$

5. Calculate the temperature and humidity value

Note: The calibration status check in the first step only needs to be checked when the power is turned on. No operation is required during the acquisition process.

Trigger measurement data

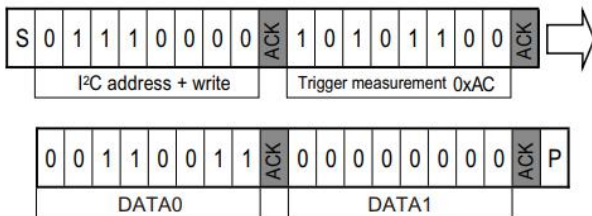

Read temperature and humidity data

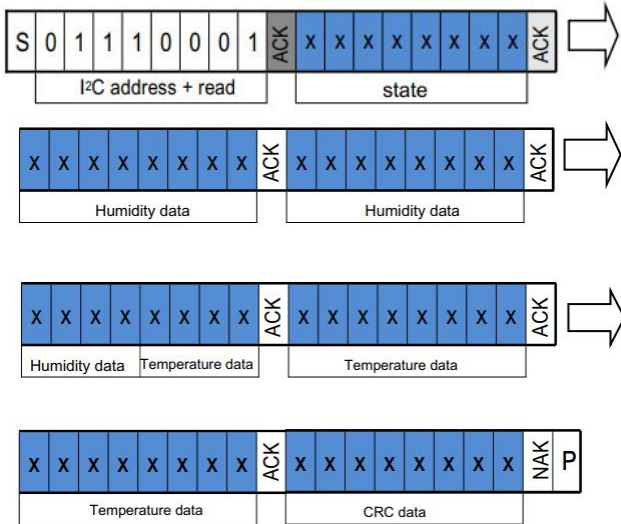

Note: The sensor needs time to collect. After the host sends a measurement command (0xAC), delay more than 80 milliseconds before reading the converted data and judging whether the returned status bit is normal. If the status bit [Bit7] is 0, it means that the data can be read normally. When it is 1, the sensor is busy, and the host needs to wait for the data processing to complete.

6 Signal conversion

6.1 Relative humidity conversion

The relative humidity RH can be calculated according to the relative humidity signal SRH output by SDA through the following formula (the result is expressed in %RH):

$$RH[\%] = \left(\frac{S_{RH}}{2^{20}}\right) * 100\%$$

6.2 Temperature conversion

The temperature T can be calculated by substituting the temperature output signal ST into the following formula: (The result is expressed in temperature °C):

$$T[°C] = \left(\frac{S_T}{2^{20}}\right) * 200 - 50$$

7 Environmental stability

If the sensor is used in equipment or machinery, make sure that the sensor used for measurement and the sensor used for reference sense the same temperature and humidity. If the sensor is placed in the equipment, the response time will be prolonged, so ensure that sufficient measurement time is reserved in the program design. The DHT20 sensor is based on Austrian

Song temperature and humidity sensor corporate standards are tested. The performance of the sensor under other test conditions is not guaranteed and cannot be used as a part of the sensor's performance. Especially for specific occasions required by users, no promises are made.

8 Packing Instructions

8.1 Transport Packing

All DHT20 sensors have laser markings on the back. See Figure 12.

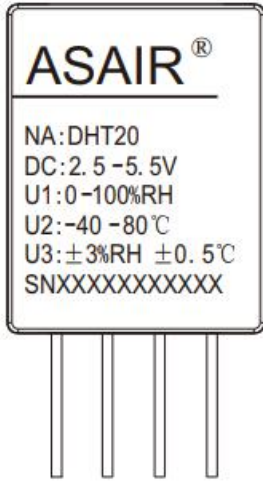

Figure 12 Sensor laser marking

The anti-static bag is also affixed with a label, as shown in Figure 13, and provides other tracking information.

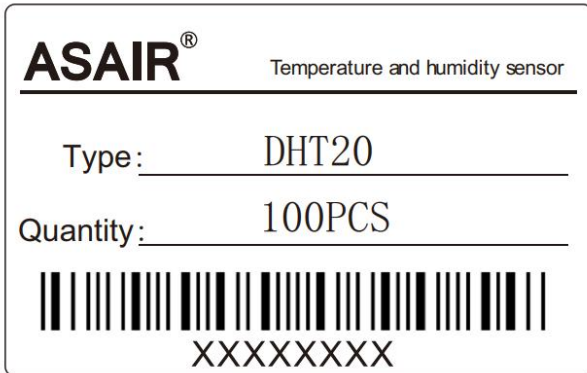
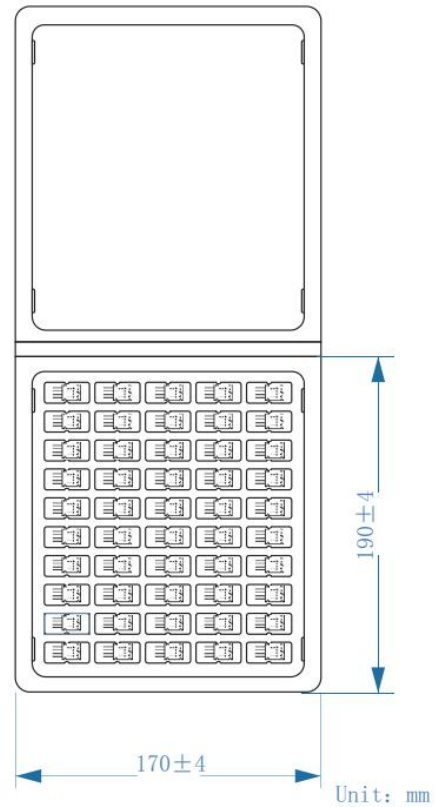

Figure 13: The label on the anti-static bag

8.2 Transport packaging

DHT20 is packaged in trays, each blister packs 50 sensors, and every two blister boxes are sealed in an anti-static shielding bag, a total of 100 sensors. The packaging diagram with sensor positioning is shown in Figure 14. The blister box is placed in an anti-static shielding bag.



DHT20Package	Quantity	Weight
Single Sensor	1pcs	About 0.9g
Per Plate	50pcs	About 70g
Per Bag	2 trays/100pcs	About 145g

Figure 14 Location map of blister box and sensor

Attention

Warning, personal injury

Do not apply this product to safety protection devices or emergency stop equipment, and any other applications that may cause personal injury due to the product's failure. Do not use this product unless there is a special purpose or use authorization. Refer to the product data sheet and application guide before installing, handling, using or maintaining the product. Failure to follow this recommendation may result in death and serious personal injury.

If the buyer intends to purchase or use Aosong's products without obtaining any application licenses and authorizations, the buyer will bear all the compensation for personal injury and death arising therefrom, and exempt Aosong's managers and employees and affiliated subsidiaries from this. Agents, distributors, etc. may incur any claims, including: various costs, compensation fees, attorney fees, etc.

ESD Protection

Due to the inherent design of the component, it is sensitive to static electricity. In order to prevent the damage caused by static electricity or reduce the performance of the product, please take necessary anti-static measures when using this product.

Quality Assurance

The company provides a 12-month (1 year) quality guarantee (calculated from the date of shipment) to direct purchasers of its products, based on the technical specifications in the product data manual published by Aosong. If the product is proved to be defective during the warranty period, the company will provide free repair or replacement. Users need to satisfy the following conditions:

- Notify our company in writing within 14 days after the defect is found.
- The defect of this product will help to find out the deficiency in design, material and technology of our product.
- The product should be sent back to our company at the buyer's expense.
- The product should be within the warranty period.

The company is only responsible for products that are defective when used in applications that meet the technical conditions of the product. The company does not make any guarantees, warranties or written statements about the application of its products in those special applications. At the same time, the company does not make any promises about the reliability of its products when applied to products or circuits.

This manual may be changed at any time without notice.

Copyright® 2021, **ASAIR®**